

## Variante 1 / 19" Gehäuse

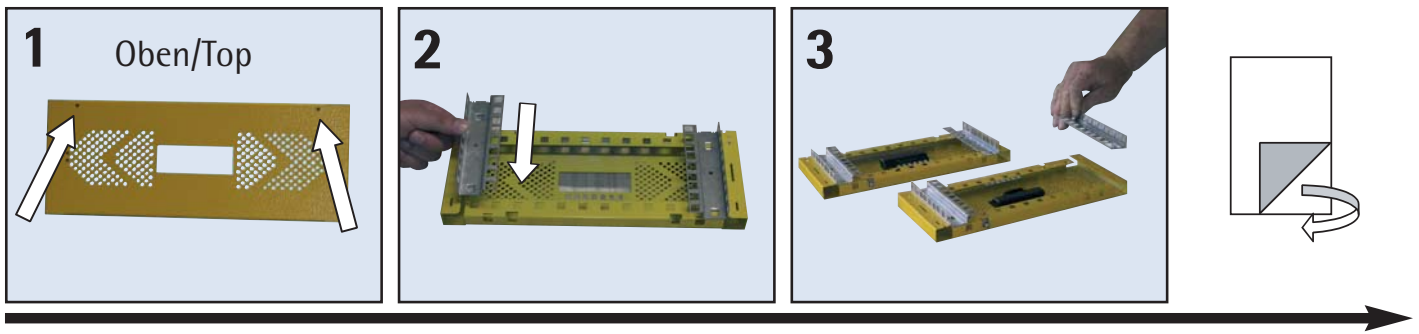

## Variante 2 / Tischgehäuse

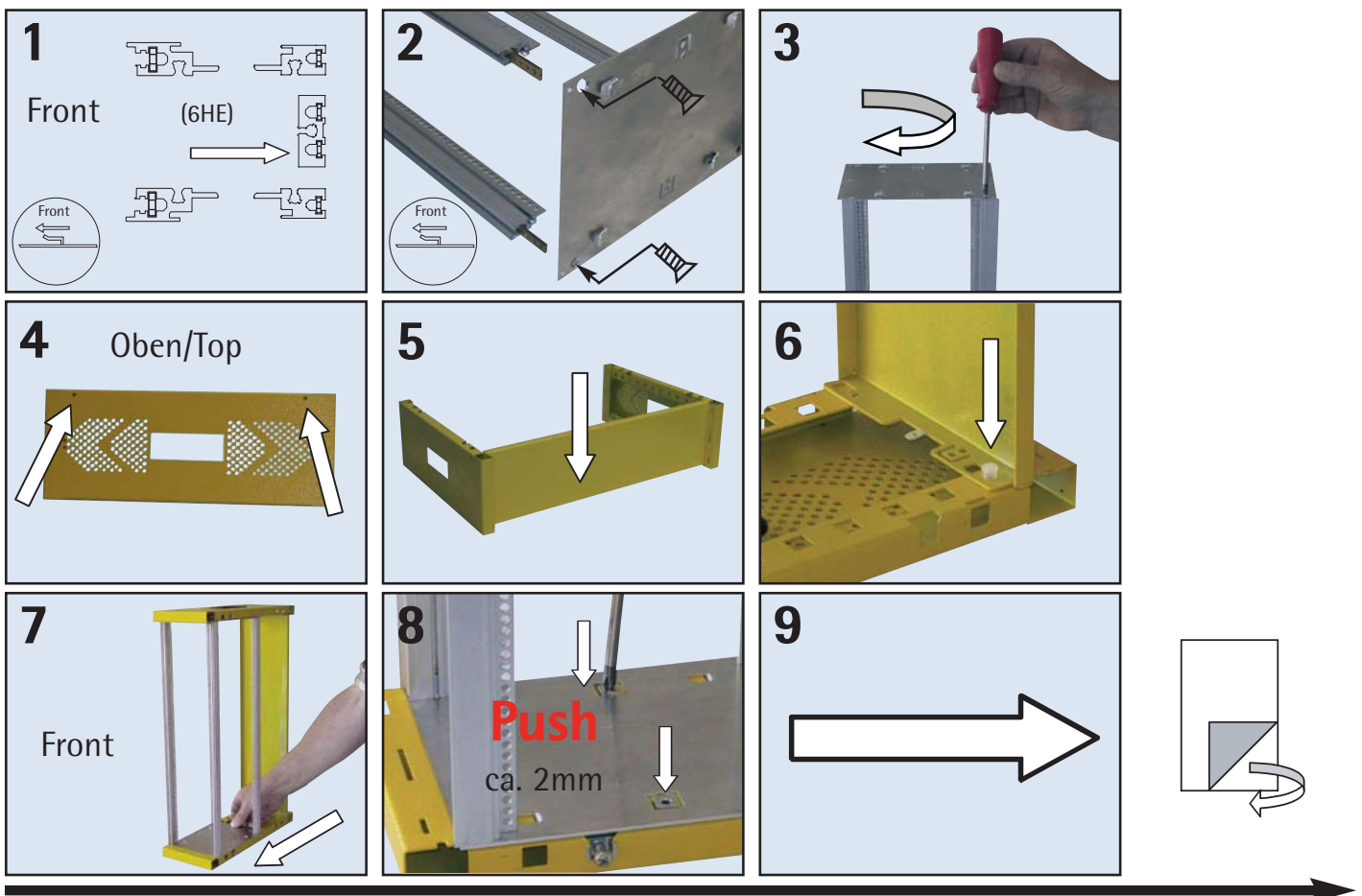

## Variante 3 / Universalgehäuse

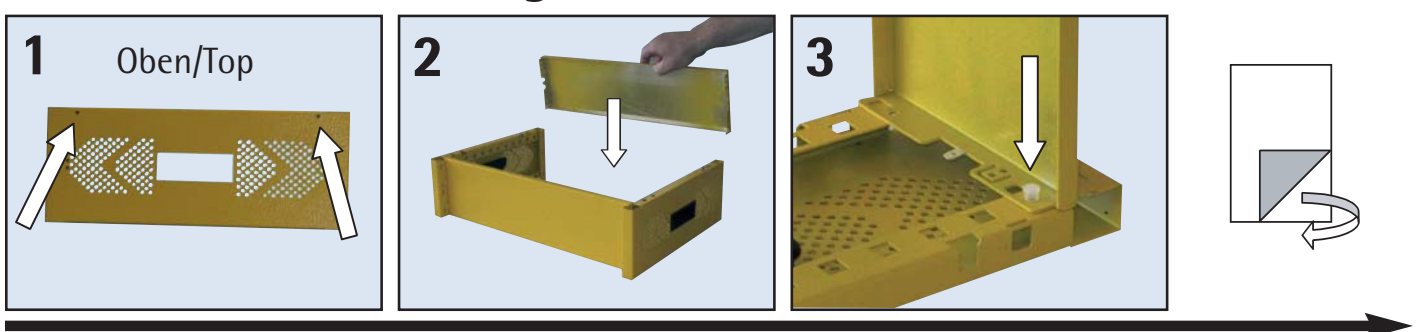

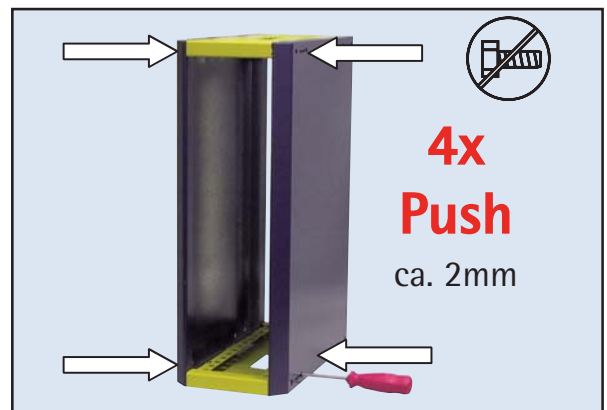
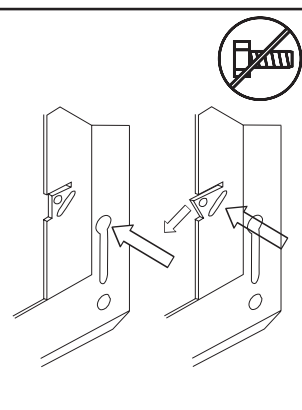
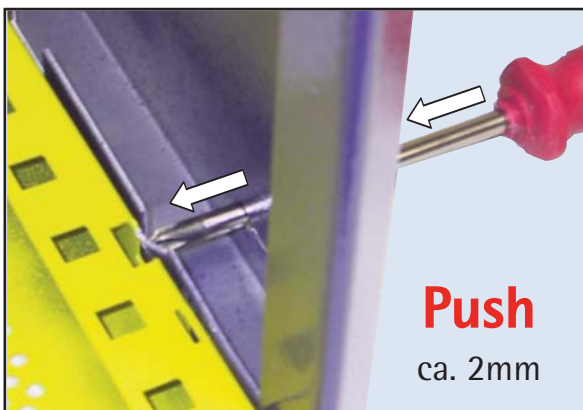
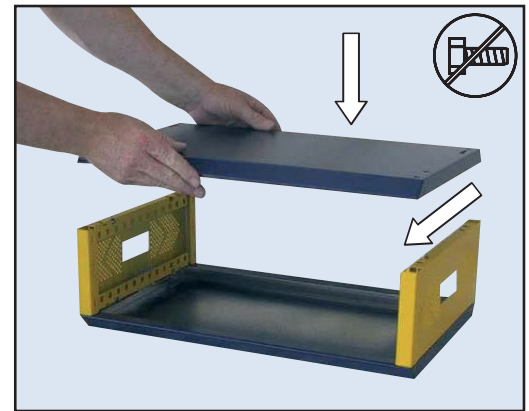
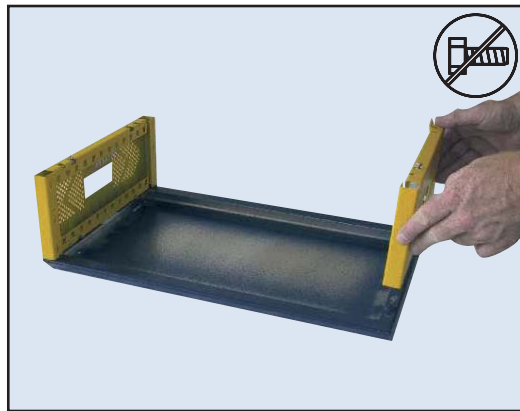
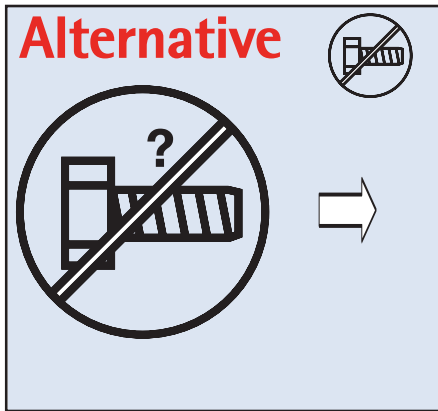
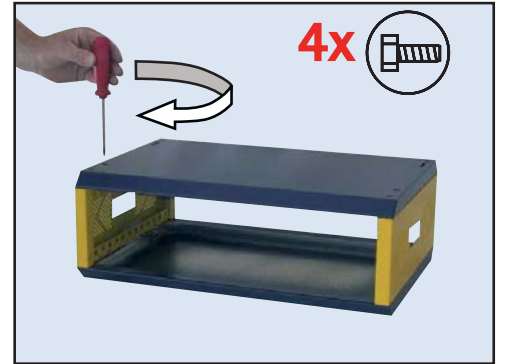
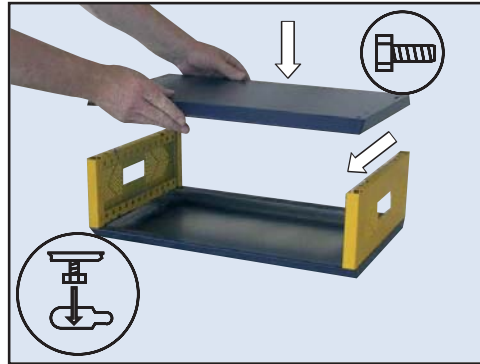
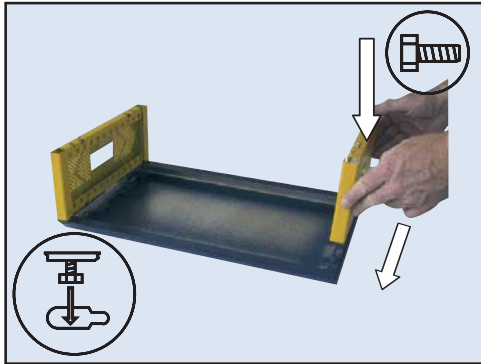
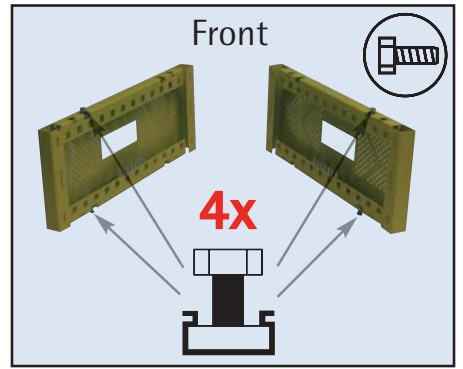
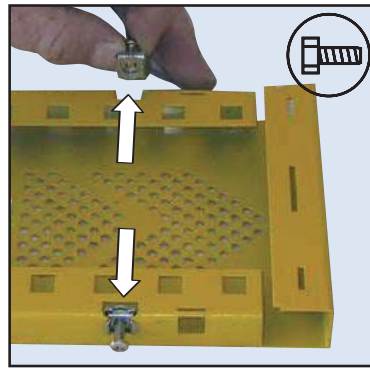
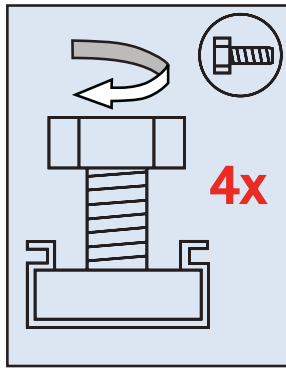
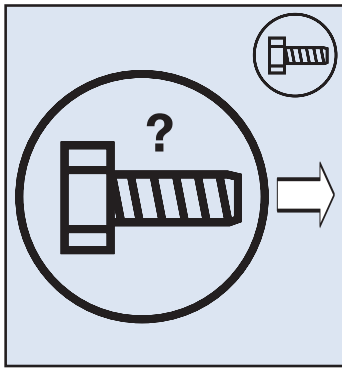

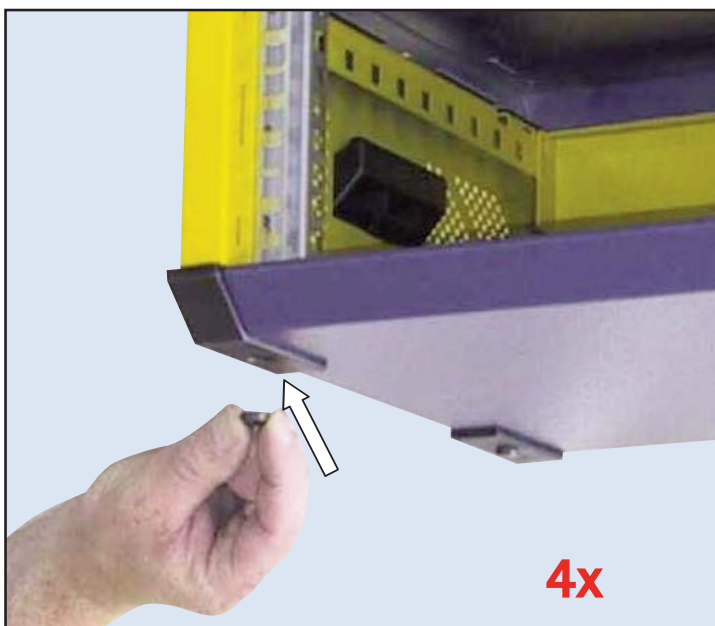
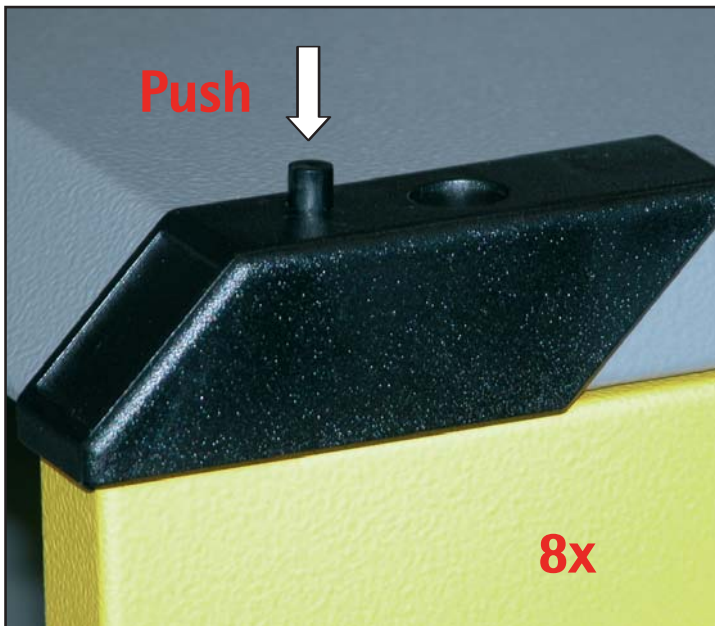
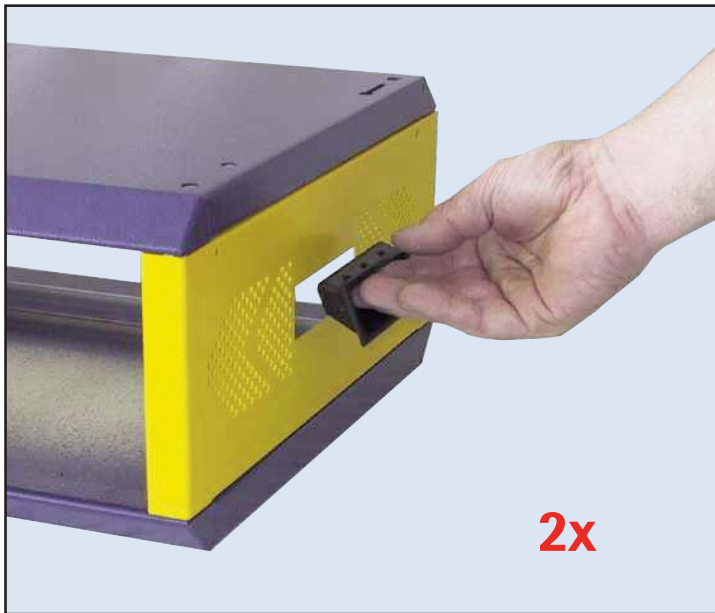

# Montageanleitung Zubehör

## Wandmontage Set

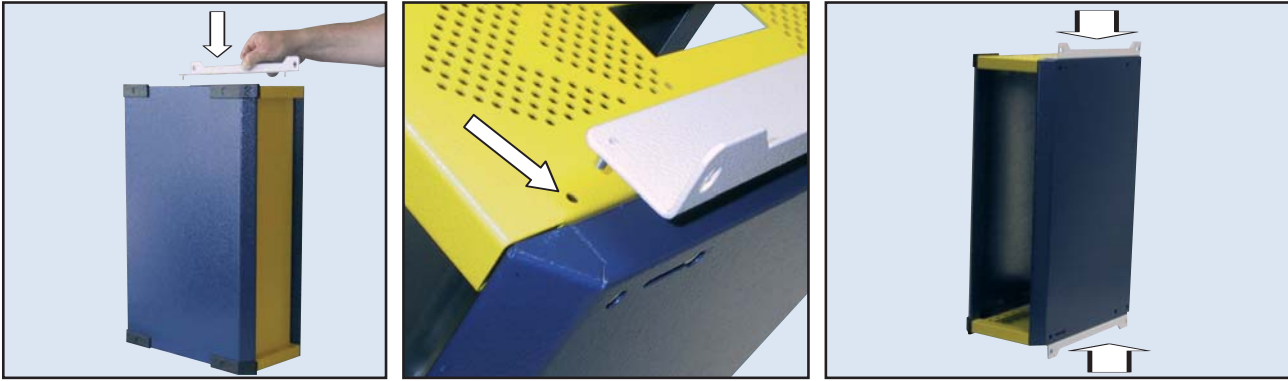

## Stecktür

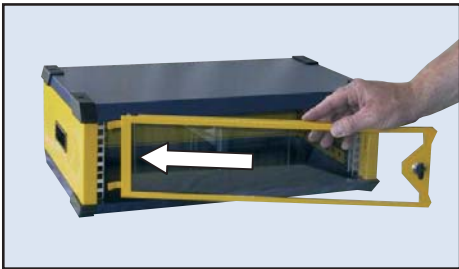

## Lüfterhalter mit 12 V Lüfter

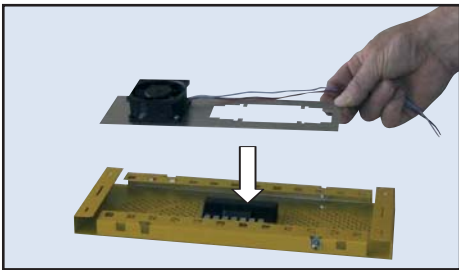

## Sichtblendensatz 50 mm

