



The tailor-made enclosure

The proven PROFI CASE small case series is characterised by its timeless design and simple and functional construction.

PROFI CASE



Small case PROFI CASE

- simple construction
- short assembly time
- available with plastic side piece (series 415) or aluminium extrusion side piece (series 416)
- available as ventilated/partially ventilated or solid models
- special sizes available on request

Truly versatile . . .

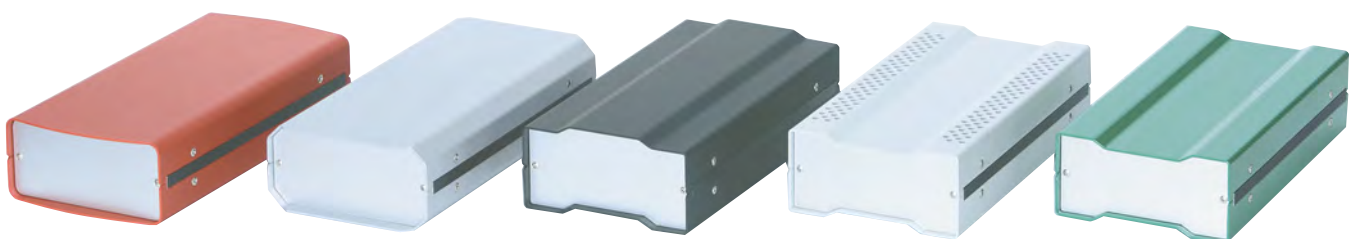



415/416 • Small case PROFI CASE

Small case PROFI CASE

Application:

for 2 or 4 PC boards or customised electronic components

Construction:

two aluminium half shells are attached with **plastic side pieces (series 415)** or **aluminium extrusions (series 416)** and screwed together from the outside of the case.

Integrated grooves (width: 2 mm) in the side pieces allow the installation of PCB's (thickness 1,6 mm) or mounting panels.

Finish:

half shells, RAL 7035 light grey
side parts, RAL 9005 deep black

Protection system:

IP 40: solid

IP 20: ventilated

Delivery:

not assembled

Other colours and dimensions on request!

Please order front 7 rear plate [6] and prop-up handle [7] separately.

Delivery

Item	Pc.	Description
1	2	Top/ bottom cover
2	2	Plastic side pieces (series 415, H=55mm)
	4	Plastic side pieces (series 415, H=90mm)
	2	Aluminium extrusion side pieces (series 416)
3	2	Side panels (series 415, H=90mm)
4	4	Adhesive feet
5		Assembly material

PROFI CASE 415 H = 55 mm

solid

one shell ventilated

both shells ventilated



PROFI CASE 415 H = 90 mm

solid

one shell ventilated

both shells ventilated

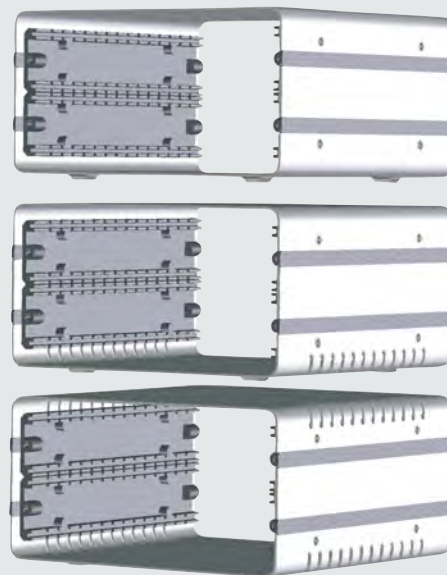

PROFI CASE 416 H = 55 mm

solid

one shell ventilated

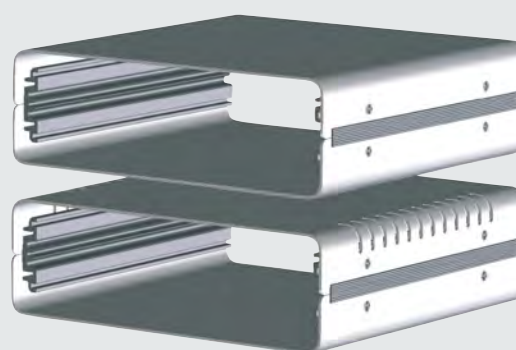



Small case PROFI CASE • 415/416

PCB dimensions	Case height	Case depth	Usable depth	Case width	Usable width	Order no.			 6 Front panels / rear panels anodised RAL 7035	
						solid IP 40	one shell ventilated IP 20	both shells ventilated IP 20		
mm	H mm	D mm	d mm	W mm	w mm					
100 x 160	55	175	160,5	115	101	415-303	415-323	415-343	415-103	415-123
120 x 160	55	175	160,5	135	121	415-305	415-325	415-345	415-105	415-125
160 x 160	55	175	160,5	175	161	415-302	415-322	415-342	415-102	415-122
190 x 160	55	175	160,5	205	191	415-301	415-321	415-341	415-101	415-121
233,35 x 160	55	175	160,5	248,5	234,5	415-304	415-324	415-344	415-104	415-124
100 x 210	55	225	210,5	115	101	415-003	415-023	415-043	415-103	415-123
160 x 210	55	225	210,5	175	161	415-002	415-022	415-042	415-102	415-122
190 x 210	55	225	210,5	205	191	415-001	415-021	415-041	415-101	415-121
233,35 x 210	55	225	210,5	248,5	234,5	415-004	415-024	415-044	415-104	415-124

PCB dimensions	Case height	Case depth	Usable depth	Case width	Usable width	Order no.			 6 Front panels / rear panels anodised RAL 7035	
						solid IP 40	one shell ventilated IP 20	both shells ventilated IP 20		
mm	H mm	D mm	d mm	W mm	w mm					
100 x 160	90	175	160,5	115	101	415-313	415-333	415-353	415-113	415-133
120 x 160	90	175	160,5	135	121	415-315	415-335	415-355	415-115	415-135
160 x 160	90	175	160,5	175	161	415-312	415-332	415-352	415-112	415-132
190 x 160	90	175	160,5	205	191	415-311	415-331	415-351	415-111	415-131
233,35 x 160	90	175	160,5	248,5	234,5	415-314	415-334	415-354	415-114	415-134
100 x 210	90	225	210,5	115	101	415-013	415-033	415-053	415-113	415-133
160 x 210	90	225	210,5	175	161	415-012	415-032	415-052	415-112	415-132
190 x 210	90	225	210,5	205	191	415-011	415-031	415-051	415-111	415-131
233,35 x 210	90	225	210,5	248,5	234,5	415-014	415-034	415-054	415-114	415-134

PCB dimensions	Case height	Case depth	Usable depth	Case width	Usable width	Order no.		 6 Front panels / rear panels anodised RAL 7035	
						solid IP 40	one shell ventilated IP 20		
mm	H mm	D mm	d mm	W mm	w mm				
100 x 160	55	175	160,5	115	101	416-303	416-323	415-103	415-123
160 x 160	55	175	160,5	175	161	416-302	416-322	415-102	415-122
190 x 160	55	175	160,5	205	191	416-301	416-321	415-101	415-121
100 x 210	55	225	210,5	115	101	416-003	416-023	415-103	415-123
160 x 210	55	225	210,5	175	161	416-002	416-022	415-102	415-122
190 x 210	55	225	210,5	205	191	416-001	416-021	415-101	415-121



7 Prop-up and carrying handle



- consists of handle brackets and a handle piece which can be cut to the appropriate length
- handle can be set 30° by pressing a button to snap it into place
- attached by a single hole on both sides

Material:

handle extrusion: anodised aluminium
handle brackets: black polyamide

Load capacity:

25 kg

Determine the length of the handle section you need using the following formula:

handle section length (L) =
case width (W) + 16mm

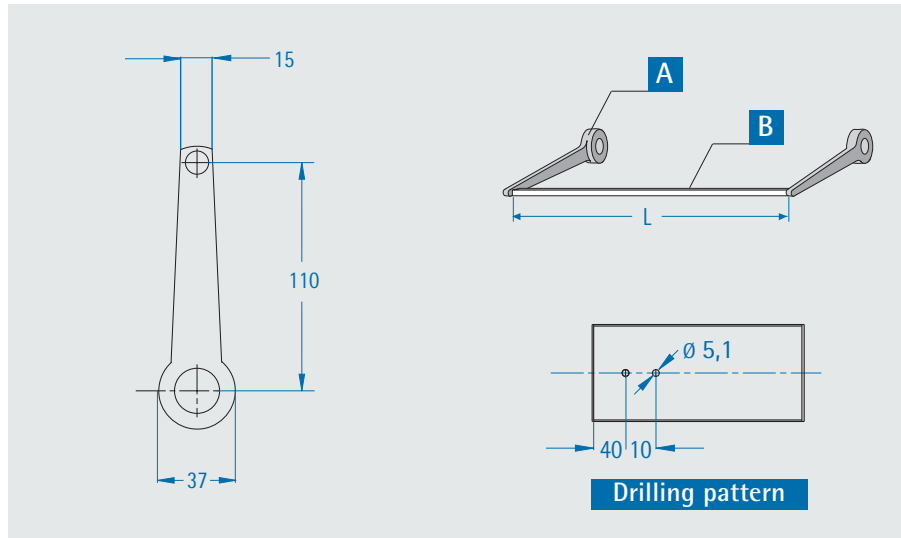

A Handle brackets

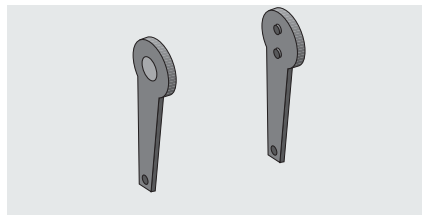

Order no. (pair)

615-060

B Handle section

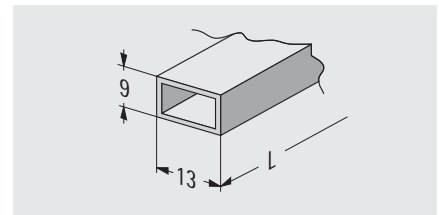

- 1m piece to cut to appropriate length

Order no. (1 m)

615-061